

COOK & GRILL STOVE

Model 43343

ASSEMBLY AND OPERATING INSTRUCTIONS

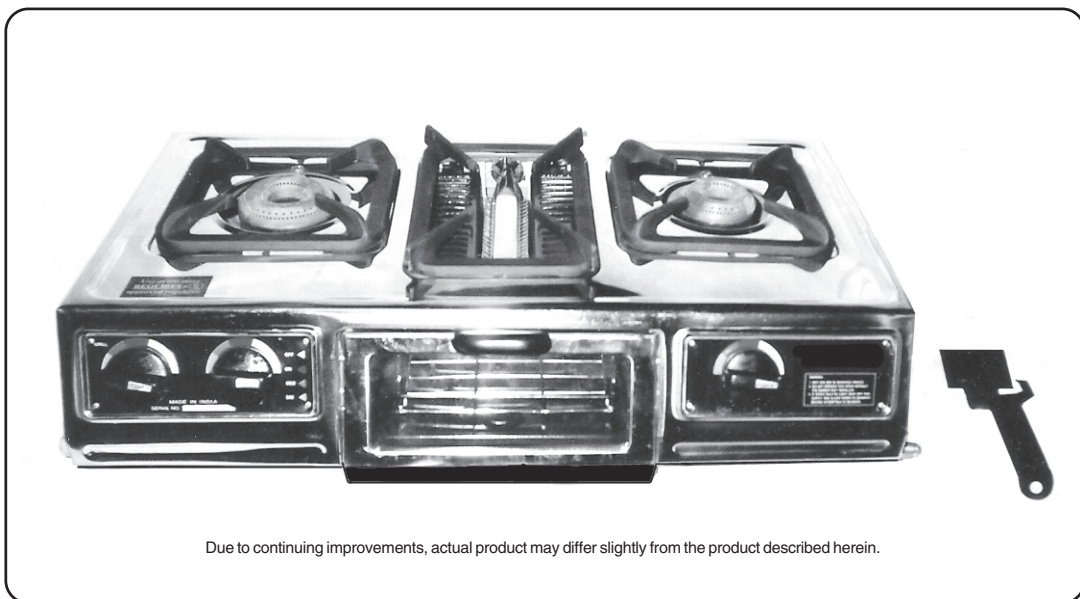

3491 Mission Oaks Blvd., Camarillo, CA 93011
Visit our Web site at: <http://www.harborfreight.com>

**TO PREVENT SERIOUS INJURY,
READ AND UNDERSTAND ALL WARNINGS
AND INSTRUCTIONS BEFORE USE.**

Copyright© 2005 by Harbor Freight Tools®. All rights reserved. No portion of this manual or any artwork contained herein may be reproduced in any shape or form without the express written consent of Harbor Freight Tools.

PRODUCT SPECIFICATIONS

Item	Description
Fuel Source	Standard LP Gas Tank (not included)
Product Compatibility	For Use With UL Listed LP Regulator & Hose Kits such as: Model 91357 Or Model 91359 (neither included)
Number of Burners	3
Maximum BTU Output	21,000 Total BTU's (7,800 BTU's Big Burner, 6,600 BTU's Grill Burner, 6,600 BTU's Small Burner)
Ignition System	Manual (Requires Lighting w/Matches)
Overall Dimensions	24-1/2" W x 13-1/2" Deep x 7" H
Center Grill Dimensions	5-7/8" W x 8-3/4" L
Oven Dimensions	8-1/2" W x 11" Deep x 3-3/4" H
Oven Rack Dimensions	6-3/4" W x 7-1/4" Deep x 2" H
Oven Tray Dimensions	8" W x 9-1/2" Deep

SAVE THIS MANUAL

You will need this manual for the safety warnings and precautions, assembly, operating, inspection, maintenance and cleaning procedures, parts list and assembly diagram. Keep your invoice with this manual. Write the invoice number on the inside of the front cover. Keep this manual and invoice in a safe and dry place for future reference.

UNPACKING

When unpacking, check to make sure all the parts shown *for your Model* in the **Parts List on page 10** are included. If any parts are missing or broken, please call Harbor Freight Tools at the number shown on the front cover of this manual as soon as possible.

GENERAL SAFETY WARNINGS AND PRECAUTIONS

 **WARNING!** When using this product, basic safety precautions should always be followed to reduce the risk of personal injury and damage to equipment.

1. **Keep children away.** Children must never be allowed in the work area. Do not let them handle, move, or adjust this product.
2. **Store idle equipment.** When not in use, this product must be stored in a dry location to inhibit rust. Always lock up tools and keep out of reach of children.

Rev 02/07

3. **Check for damaged parts.** Before using any product, any part that appears damaged should be carefully checked to determine that it will operate properly and perform its intended function. Check for any broken parts or mounting fixtures, and any other condition that may affect proper operation. Any part that is damaged should be properly repaired or replaced by a qualified technician. Do not use the product if any switch does not turn on and off properly.
4. **Replacement parts and accessories.** When servicing, use only identical replacement parts. Use of any other parts will void the warranty. Only use accessories intended for use with this product. Approved accessories are available from Harbor Freight Tools.
5. **Do not operate this product if under the influence of alcohol or drugs.** Read warning labels if taking prescription medicine to determine if your judgement or reflexes are impaired while taking drugs. If there is any doubt, do not operate this product.
6. **Maintenance.** For your safety, service and maintenance should be performed regularly by a qualified technician.

SPECIFIC SAFETY WARNINGS AND PRECAUTIONS



1. **WARNING! This unit must only be used with an approved, UL listed LP regulator. NEVER attempt to use this item without a regulator.**
2. **Read these instructions carefully before setting up and using the Propane Stove. Do not allow anyone who has not read the instructions to assemble, light, or operate the Stove.**
3. **Improper assembly, installation, adjustment, alteration, service, use, or maintenance can cause property damage, PERSONAL INJURY, or DEATH.**
4. **Service and repair should be done only by a qualified service technician. The Propane Stove should be inspected before each use and at least annually by a qualified service technician. More frequent cleaning may be required as necessary. It is imperative that the Burner(s), Temperature Control Knob(s), and circulating fuel/air passageways of the Propane Stove should be kept clean.**
5. **This Propane Stove must be used only with HD-5 propane gas. The propane tank should hold no more than 20 pounds of LP gas. Do not use bulk tanks of larger capacity. Do not use any other fuel. The Stove must be used only with a vapor withdrawal LP propane tank equipped with a POL valve. The tank must be constructed and marked in such a way as to comply with the specifications for LP gas tanks by the U.S. Department of Transportation (DOT).**

6. **The use of the Propane Stove must be in conformity with local codes or, in the absence of local codes, with the standard for storage and Handling of Liquefied Petroleum Gases, ANSI/NFPA 58. For Canada, the use must be in accordance with the current CAN/CGA B149.2 installation codes.**

CARBON MONOXIDE INHALATION HAZARD



1.  The Propane Stove is an unvented LP Gas-fired stove. **It must never be used inside vehicles, campers, in a house, or any other sealed structure. Carbon monoxide is produced during operation and is DEADLY in a closed environment.** Early signs of carbon monoxide poisoning resemble the flu, with headaches, dizziness, or nausea. If you have these signs, the Propane Stove may not be working properly or is improperly vented. Get fresh air **immediately**.
2. **If you smell gas:** Shut off gas to the appliance. Extinguish any open flame. Never light a match. Never turn on an electrical switch. Evacuate the area at once. Call for professional help.

RISK OF FIRE AND/OR EXPLOSION

1.  **Do not store extra propane tanks in the vicinity of the Propane Stove or any other appliance.**
2.  **If gas is smelled during operation, immediately close the valve on the propane tank.** Propane gas is odorless. An odor-making agent is added to propane/LP gas to enable you to smell the gas if it may be leaking.
3. **If the Propane Stove shuts off during operation, close the valve on the propane tank. Check the amount of gas in the tank and wait 5 minutes for the gas to clear before restarting.** If it continues to shut off during operation, have it serviced by a qualified technician.
4. **Never place the Propane Stove within 15 feet of flammable objects such as wood, trees, overhangs, and umbrellas. This stove also requires a clearance of at least 3 feet from nonflammable materials to allow proper combustion.**

5. **Keep solid combustibles such as paper or cardboard a safe distance away from the Propane Stove. Never use the Stove in spaces which do or may contain volatile or airborne combustibles, or products such as gasoline, solvents, paint thinner, dust particles or unknown chemicals.**
6. **Always operate the Propane Stove with the propane tank in its vertical upright position, on a noncombustible surface.** While in operation, do not tilt or lean the propane tank on its side. Never turn the tank upside down, not even when it seems empty, as this may cause clogging of valves and components which could lead to dangerous flare-ups or fire.
7. **This Propane Stove must be positioned and operated so that it is not directly exposed to water spray, rain, or dripping water.**
8. **Make sure to remove ALL packing materials before using the Propane Stove.**

RISK OF BURNS -- STOVE GETS VERY HOT DURING USE.

1.  **Do not attempt to move the Propane Stove while it is in operation.** Turn it off and wait one-half hour until it cools down before moving.
2. **Do not touch the Grill(s) or Burner(s) while the Propane Stove is lit.** Before servicing, wait one-half hour for the Propane Stove to cool down.
3. **Children and adults should be alerted to the hazards of high surface temperatures and should stay away to avoid burns or clothing ignition.**
4. **Young children should be carefully supervised when they are in the area of the Propane Stove.**
5. **Clothing or other flammable materials should not be hung from the Propane Stove, or placed on or near the Stove.**
6.  **WARNING!** The brass components of this product contain lead, a chemical known to the State of California to cause birth defects (or other reproductive harm). (*California Health & Safety Code 25249.5, et seq.*)
7.  **WARNING!** The warnings, precautions, and instructions discussed in this instruction manual cannot cover all possible conditions and situations that may occur. It must be understood by the operator that common sense and caution are factors which cannot be built into this product, but must be supplied by the operator.

ASSEMBLY INSTRUCTIONS

1. **⚠ WARNING!** Always make sure to close the valve on the propane tank (not included) prior to assembling the Propane Stove, performing maintenance, or making any adjustments to the unit.
2. **⚠ CAUTION!** This product is *machine manufactured*. Be aware of sharp edges. Use heavy duty work gloves and ANSI approved safety impact eye goggles when assembling.
3. Turn the Propane Stove upside down, and attach a Rubber Foot (7) to each corner of the unit. **(See Assy. Diagram.)**
4. To attach the *three* Temperature Control Knobs (4), loosen the countersunk Screw in the Knob. Insert the Knob onto the Burner Control Shaft by aligning the flat edges of the Knob and Shaft. Then, firmly tighten the Screw. **(See Figure A.)**
5. **NOTE:** The Propane Stove requires the attachment and use of the **Model 91357 LP Regulator & Hose Kit** or **Model 91359 LP Regulator & Hose Kit** which are sold separately by Harbor Freight Tools. **(See Figure A.)**
6. **A LP regulator MUST be used:** To attach the LP Regulator & Hose Kit to the Propane Stove, remove the plastic protective cap from the Inlet Connection Nozzle (5) on the Propane Stove. Then, screw the Hose Connector firmly onto the Inlet Connection Nozzle. **(See Figure A.)**

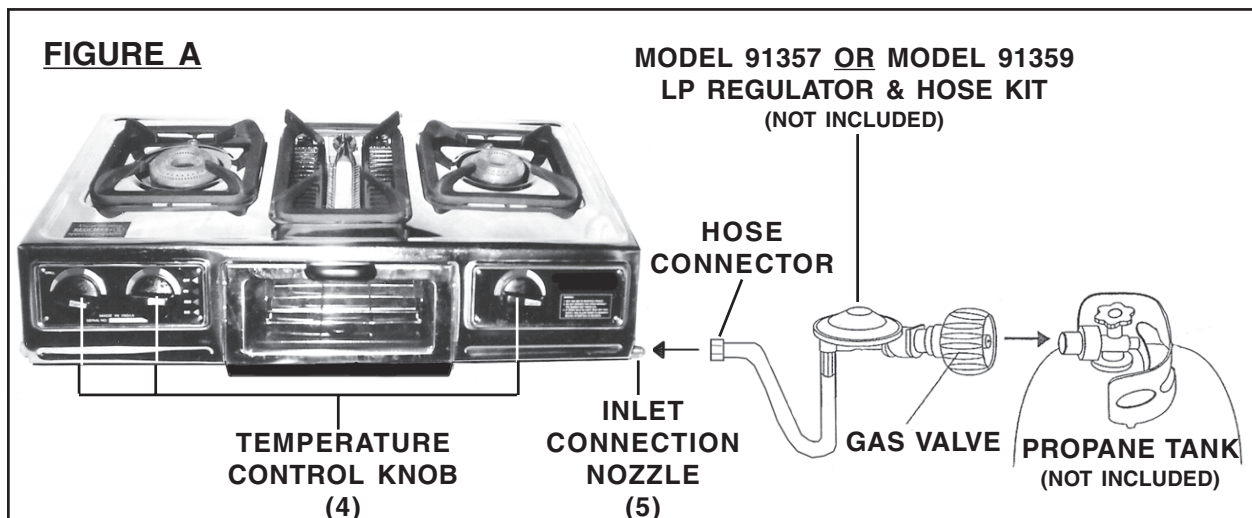



7. **NOTE:** The propane tank used must be constructed and marked in accordance with the specifications for LP propane cylinders by the U.S. Department of Transportation. **(See Figure A.)**
8. To connect to the propane tank, first make sure the Temperature Control Knobs (4) of the Propane Stove are in their “**OFF**” positions. Then, screw the Gas Valve of the LP Regulator & Hose Kit firmly onto the propane tank’s discharge pipe. **(See Figure A.)**

OPERATING INSTRUCTIONS

1.  **CAUTION!** Always use clean equipment and utensils. Before using the Propane Stove, and after using this product, clean all parts in warm, clean water and antibacterial soap. Then, thoroughly dry.
2. **NOTE:** Higher altitudes may affect the cooking efficiency of the Propane Stove.
3. Make sure the Propane Stove and propane tank are located on a clean, dry, level surface capable of supporting the weight of the Stove and propane tank. Keep the Propane Stove and propane tank away from other flammable objects.
WARNING! NOT FOR INDOOR USE.
4. Check to make sure the Temperature Control Knobs (4) on the Propane Stove are in their “**OFF**” positions. Open the gas valve on the propane tank and check and smell for gas leaks. Perform a bubble test by applying warm soapy water over every joint, regulator, fitting, and anywhere else there may be a possible leak. Observe carefully to see if bubbles expand, indicating a leak. A large leak can blow the soapy solution away instead of forming bubbles. If leaks are found, do not use the Propane Stove until the leaks have been stopped. After testing, make sure to close the gas valve on the propane tank.
5. *To use the Burners (2 and 2A),* open the gas valve on the propane tank. Apply a long, lighted match or a fireplace lighter to the Burner which is to be lit. **Keep fingers and hands well away from the Burners.** Next, push the relevant Temperature Control Knob (4) and turn it to its “**ON**” position. Once the Burner is lit, safely dispose the match and adjust the Temperature Control Knob to the desired setting. **The Grill Chamber (3) will be hot while the Middle Burner is in use. (See Assy. Diagram.)**
6. *To use the Grill Chamber (3),* open the Grill Door (8) and remove the Tray with Rack (9). Place the food on the Rack and push the Tray into the Grill Chamber. Close the Grill Door securely. Then, light the center Burner (2A) to grill the food. When the food is cooked, turn off the gas and use the Grill Handle (10) to remove the Tray with Rack. **The center burner will have an open flame while the Grill Chamber (3) is in use; take appropriate precautions. (See Assy. Diagram.)**

REV 12/06, 02/07

7. While cooking, avoid spills as this may result in extinguishing the flame and clogging the Burner holes.
8. Always turn the Temperature Control Knobs (4) to their “**OFF**” positions before removing a pan from the Burners (2 and 2A) or Grill Chamber (3).
(See Assy. Diagram.)
9. When finished using the Propane Stove, turn the Temperature Control Knobs (4) to their “**OFF**” positions. Then, close the gas valve on the propane tank.
(See Assy. Diagram.)
10. The propane tank must be stored outside. If the Propane Stove is to be stored inside a building, the propane tank should be turned off, removed from the Stove, and left outside. Propane tanks must be stored outdoors in a well-ventilated area out of reach of children. Disconnected propane tanks must have threaded valve plugs (not included) tightly installed, and must not be stored in a building, garage, or any other enclosed area.
11.  **WARNING! Do not attempt to move the Propane Stove while it is on or while it is hot. Do not touch any area of the Burners (2), Tray with Rack (9), or top of the Stove’s Body (1). Serious burns will occur. Turn the Propane Stove off and wait one-half hour until it cools down before moving. (See Assy. Diagram.)**

INSPECTION, MAINTENANCE, AND CLEANING

1. **Any guard or other protective device removed for servicing the Propane Stove must be replaced prior to operating the Stove.**
2. **Before each use**, check all gas fittings for tightness.
3. **Before each use**, check for cracks, excessive abrasion or wear, and any other damage.
4. **Before and after each use**: Before using the Propane Stove, and after using this product, clean all parts in warm, clean water and antibacterial soap.
5. **During each use**, visually check the burner’s flame. If the flame looks improper, have the Propane Stove serviced by a qualified technician before use.
(See Figure B, next page.)
6. **Store the Propane Stove** in a clean, dry location out of reach of children. If storing the unit indoors, first shut off and remove the propane tank and leave it outdoors. Keep the area near the Propane Stove clear and free from combustible materials, gasoline, and other flammable vapors and liquids.

REV 12/06

7.  **CAUTION:** All maintenance, service, or repairs not listed in this manual are only to be attempted by a qualified service technician.

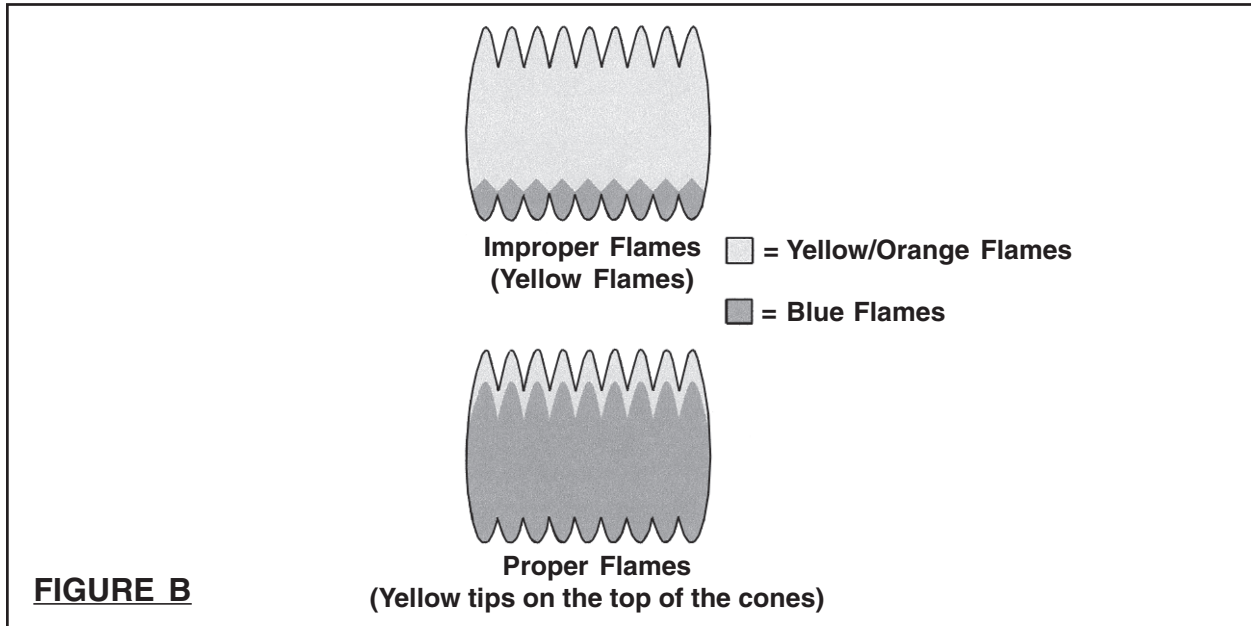

PLEASE READ THE FOLLOWING CAREFULLY

THE MANUFACTURER AND/OR DISTRIBUTOR HAS PROVIDED THE PARTS LIST AND ASSEMBLY DIAGRAM IN THIS MANUAL AS A REFERENCE TOOL ONLY. NEITHER THE MANUFACTURER OR DISTRIBUTOR MAKES ANY REPRESENTATION OR WARRANTY OF ANY KIND TO THE BUYER THAT HE OR SHE IS QUALIFIED TO REPLACE ANY PARTS OF THE PRODUCT. IN FACT, THE MANUFACTURER AND/OR DISTRIBUTOR EXPRESSLY STATES THAT ALL REPAIRS AND PARTS REPLACEMENTS SHOULD BE UNDERTAKEN BY CERTIFIED AND LICENSED TECHNICIANS, AND NOT BY THE BUYER. THE BUYER ASSUMES ALL RISKS AND LIABILITY ARISING OUT OF HIS OR HER REPAIRS TO THE ORIGINAL PRODUCT OR REPLACEMENT PARTS THERETO, OR ARISING OUT OF HIS OR HER INSTALLATION OF REPLACEMENT PARTS THERETO.

PARTS LIST AND ASSEMBLY DIAGRAM

Part	Description	Qty.	Part	Description	Qty.
1	Body	1	6	Pipe Assembly	1
2	Outer Burners	2	7	Rubber Foot	4
2A	Center Burner	1	8	Grill Door	1
3	Grill Chamber	1	9	Tray with Rack	1
4	Temperature Control Knob	3	10	Grill Handle	1
5	Inlet Connection Nozzle	1			

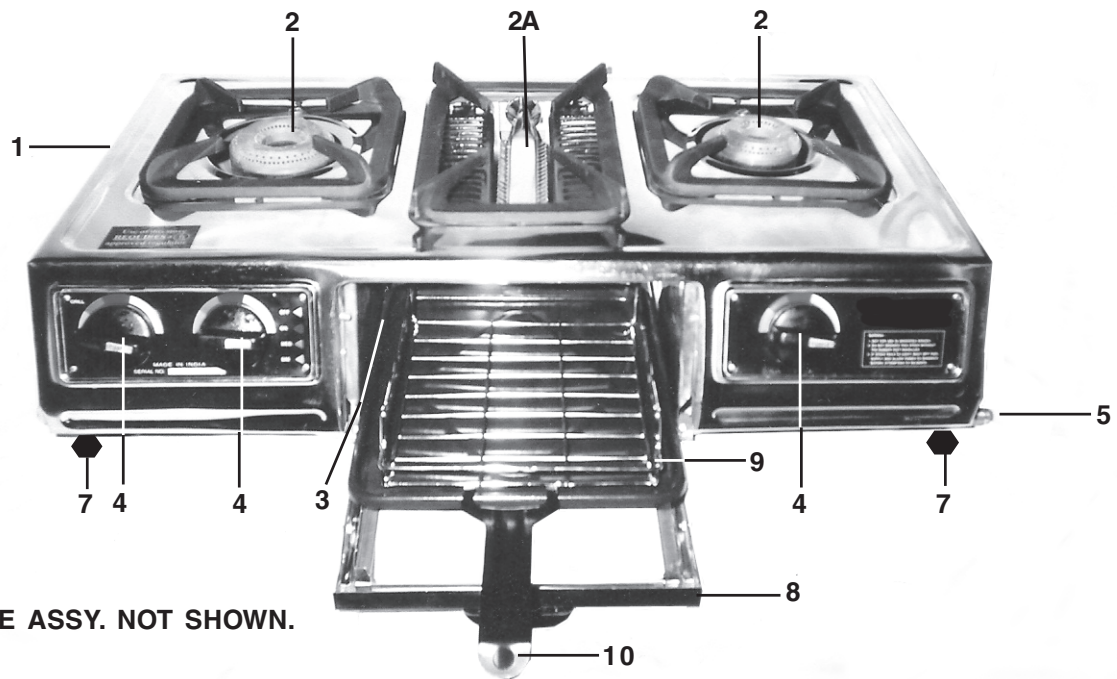

6: PIPE ASSY. NOT SHOWN.

NOTE:

Some parts are listed and shown for illustration purposes only, and are not available individually as replacement parts.

REV 12/06; 02/07